



a million voices for nature



## Design of management of rafts

Rafts are a useful way of providing island habitat in areas of deep or fluctuating water levels. Their purpose is to improve breeding success by providing areas safe from flooding, disturbance or predation. Rafts are unlikely to attract terrestrial predators and so are useful where islands would be too close to shore for safety. They also provide wildfowl with loafing spots and are often used as resting places by various bird species during the winter.

### Main factors to consider when making a raft

There are many conflicting requirements when constructing a nesting raft.

- The ability to float, preferably with the deck just above the water line.
- The ability to rise and fall easily with the water over the maximum flood range.
- Stability, so that the raft is not tipped or spun by current, waves or wind.
- A dry, sheltered nest site, which does not attract the attention of crows or other avian predators. The nest area must be high enough not to be swamped by storm waves.
- Means of access and some protection from waves and current for young birds.
- Harmonious blending with the surroundings if possible.
- Practical factors e.g. water not excessively deep, lake shore accessible by vehicle, for bringing in boat, raft and materials, and for regular maintenance checks.
- On SSSIs, formal consent may be required from NE, SNH or CCW.

### Construction

Although rafts vary in character and design, some basic considerations apply to each.

1. Timber rafts tend to absorb water and sink, although pine or other light wood floats better than heavy timber. In most cases, additional floats must be used if the raft is to last for more than one season.
2. **Flotation blocks:** Small rafts can be floated with plastic 4.5 litre containers. Slightly larger rafts will stay afloat with 22 litre plastic drums. Rafts in the range of 1.2 - 1.8 m in dimension require closed cell polystyrene blocks, polystyrene scraps, airtight metal drums (including old oil drums). Polystyrene is easily held in place and can be adjusted to achieve right buoyancy. It should be packed into strong polythene to prevent it from breaking up and littering the environment. Metal drums need to be weighted so that they do not float too high. The flotation blocks must be thoroughly cleaned before they are brought to the site to prevent pollution. Annual checks and maintenance is important to ensure that the raft remains secure and firm, and that the flotation devices are not disintegrating or leaking.

The RSPB  
UK Headquarters  
The Lodge  
Sandy  
Bedfordshire SG19 2DL  
Tel: 01767 693690

The RSPB  
Northern Ireland Headquarters  
Belvoir Park Forest  
Belfast BT8 7QT  
Tel: 028 9049 1547

The RSPB  
Scotland Headquarters  
Dunedin House  
25 Ravelston Terrace  
Edinburgh EH4 3TP  
Tel: 0131 311 6500

The RSPB  
Wales Headquarters  
Sutherland House  
Castlebridge  
Cowbridge Road East  
Cardiff CF11 9AB  
Tel: 029 2035 3000

3. **Anchors:** Two anchors are better than one and should be attached to opposite corners of the raft to keep it from swinging in the wind. Anchor to the bottom, not to the shore, to prevent vandalism and to keep rats or weasels from getting to the raft.
  - a. Anchors can be made from breeze blocks, concrete blocks etc. The wire anchor rope should be tied to a short section of chain or to an eye bolt; for large rafts use 19 mm circumference flexible steel wire rope with a 4 ton breaking strain to ensure that the mooring is secure. An anchor weighing about 50 kg is suitable for most rafts. It can be made in a large polythene garden tub half filled with scrap metal or rocks. Wrap one end of an appropriate length of chain around the scrap and fill the tub with concrete. Once the concrete has set, the anchor can be turned out of the mould and the chain bolted to the raft. Three thickness of heavy gauge (24mm) polypropylene rope can be used instead to save money, especially if the raft is in deep water. Where strong winds or currents are likely, several 50kg anchors may be needed to securely hold a 3m x 2m turned raft.

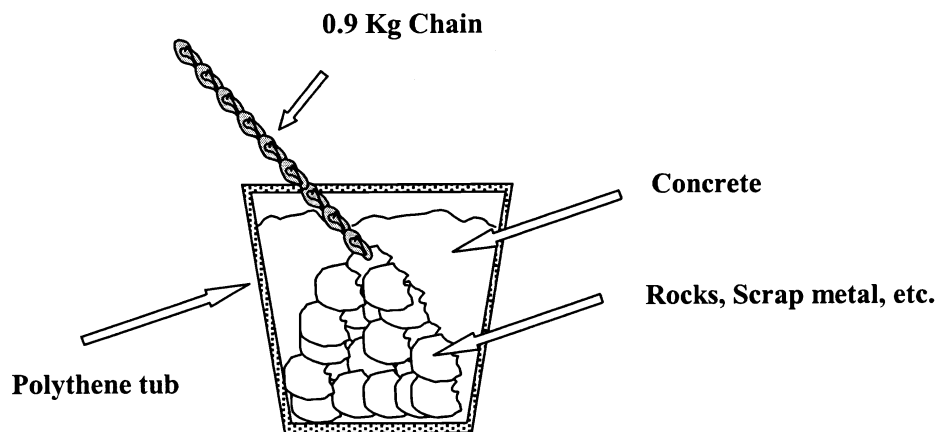

- b. Where one large anchor is too cumbersome to manage, a smaller (e.g. 9 litre) container can be used as a mould and concrete sinkers can be cast with holes through their centres. One sinker can be fastened to the end of the wire and others can be threaded on and allowed to slide to the bottom before fixing the other end of the wire to the raft.
4. Where more than three rafts are to be moored in a string there should be some additional anchor points from the middle rafts to keep the string from sagging before a strong wind and dragging the main moorings.
5. Various nest boxes and duckling ramps can be added to the raft superstructure depending on the species of birds that the raft is intended for. Duck baskets should be at least 1.2 m apart and facing away from each other. They should be tilted slightly upwards at the front and lined with dead grass or some wood shavings. Baskets should be positioned in early January and left until early September, when they should be taken up, cleaned of nesting material and stored under cover.

#### **Species specifications:**

1. Wader and tern nesting rafts, in most cases, should be bare of vegetation and covered with a material attractive to the intended nesting species.
2. Wildfowl rafts require more vegetation. Rushes, reeds or small willows are suitable, planted either around the edges or over the deck of the raft leaving pathways to the nest box or central clearing. Plants survive best on raft designs with an open mesh or slatted platform just above the water

line, covered with moisture-holding mulch in which the plants can root and through which they can reach the water.

### Some raft models

The area and water characteristics determine the best design for a raft. Some of the designs used on RSPB reserves are described below as a guide.

#### Simple log or telegraph pole rafts

Logs from nearby felling operations or used GPO poles are often available free and can be used to provide the basis both for simple rafts and more elaborate designs. Without any additional support, the timbers eventually sink low in the water and sprout a floating garden, which should prove to be attractive to nesting wildfowl if the raft is sited in a calm area.

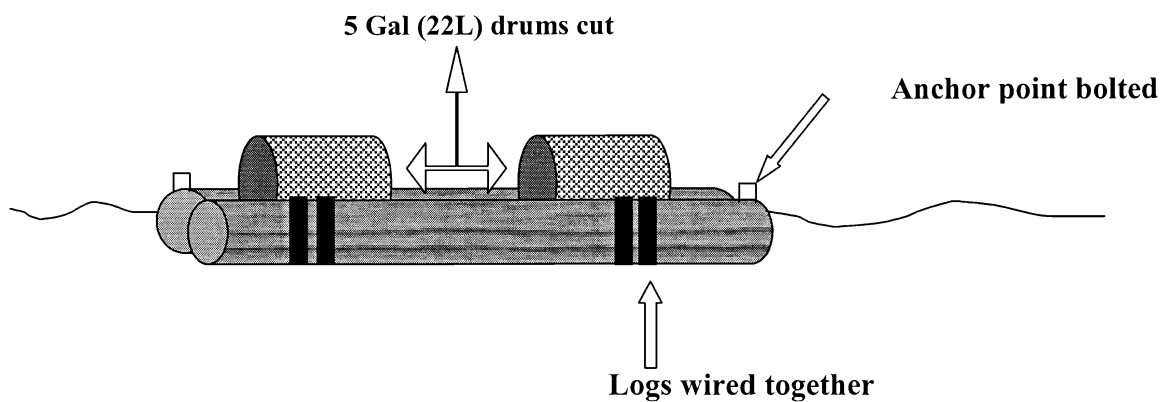

#### The standard raft

This raft is made of pressure treated (do not use CCA treated) softwood and is 3 meters square. Design includes chick shelters, a re-entry ramp and an optional security fence. Buoyancy is provided by two high-density polystyrene blocks. Raft is anchored to concrete blocks by a chain attached to a marker buoy. It is covered with gravel and rocks, and any plant growth is removed each winter.

##### *Raft platform:*

Mainframe: 100x200mm timber, bolted together in each corner through overlapping ends (two upper, two lower), one top inset 150mm to allow for re-entry ramp. Deck 25x150mm planking, laid on and nailed (75mm galvanized nails) to lower mainframe timbers. Sub frame 50x75mm runners to support flotation and strengthen deck, nailed (150mm nails); main flotation holders/deck support 50x100mm runners; sides 25x150mm planking, nailed flush with top of upper mainframe timbers along the lower sides to hold in gravel etc, and flush with the bottom of the mainframe timbers along the upper sides to hold the flotation devices in place.

##### *Buoyancy:*

Blocks of 380x600x2700mm high density polystyrene foam, painted (optional) with BP Aquaseal 44 bituminous paint (as suitable for use inside cold water tanks) to water seal and strengthen the polystyrene; two optional straps per float block, 1,420mm strips of polystyrene webbing (or 50mm chair webbing as a temporary measure, eg during launching) with eyelet holes for nailing to frame. Once in the water, the weight of the raft is sufficient to hold the polystyrene in place without any additional fixings, even in extreme conditions.

*Mooring:*

Mooring ring bolted through center of mainframe timber (bolt fixed with two nuts so that it can swivel freely), connected preferably to a chain or a 20mm diameter hawser-lay polypropylene rope (which will not rot, but can be chafed), with hard eyes and shackles each end. Tether a 30-inch circumference marker buoy to the raft end of the chain or rope with a length of polypropylene rope to allow the raft to be detached, without having to pull up or lose the anchor.

*Anchor:*

Multiple small weights (up to 1m<sup>3</sup> concrete as a total) for ease of transport. Four buckets 250mm high by 300mm diameter of concrete, eyebolt set in centre; weights connected in pairs by shackles to 300mm lengths of chain; fixed to mooring by placing two pairs of weights together with the connecting chains forming a cross, and attaching the mooring rope shackle to the point where the chains cross. Exposed sites where wind and waves are strong may require more anchor weights.

*Shelters (to protect from rain):*

These comprise 1m long 25x150mm planks located in opposite corners, nailed flat onto end of upper mainframe timber, side plank and 50x75mm end block.

*Gravel covering:*

Preferably of 15mm-25mm gravel with larger pieces and rocks to provide shelter, and give sufficient weight to push running board down to water level.

*Re- entry system (for chicks falling overboard):*

These are located on opposite (lee) side of raft to the mooring ring: running board 3m, 25x150mm plank nailed to bottom of the two lower mainframes. Ramp (1.5m, 25x150mm plank) sloping up to top corner of mainframe, supported by up stand, nailed. Block gap under raft behind ramp with 25x150mm skirt plank.

*Optional removable security fence:*

These comprise four frames 230mm by 0.3m, made from 50x50mm planks covered with 25mm chicken wire, bolted along each side and fixed at top corners.

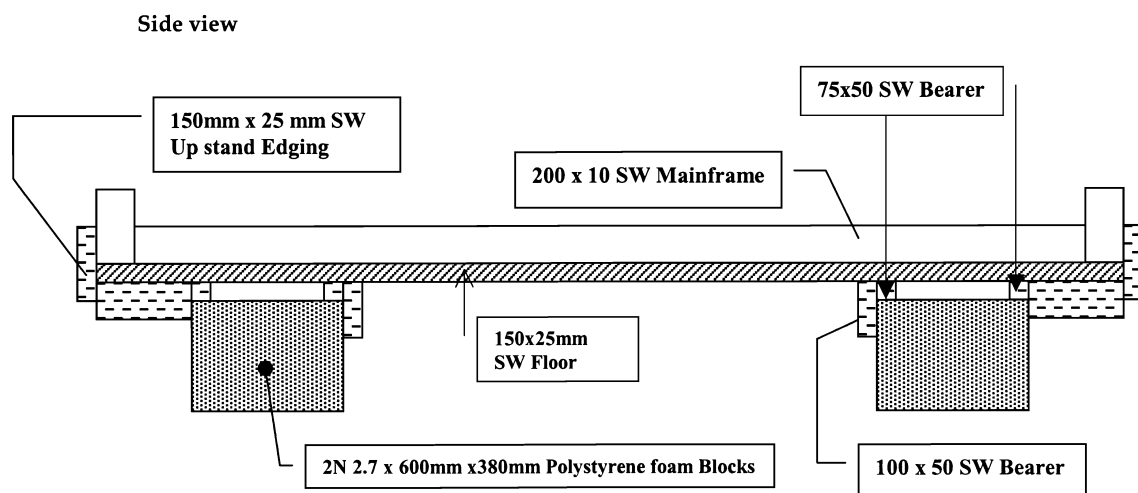

View from above

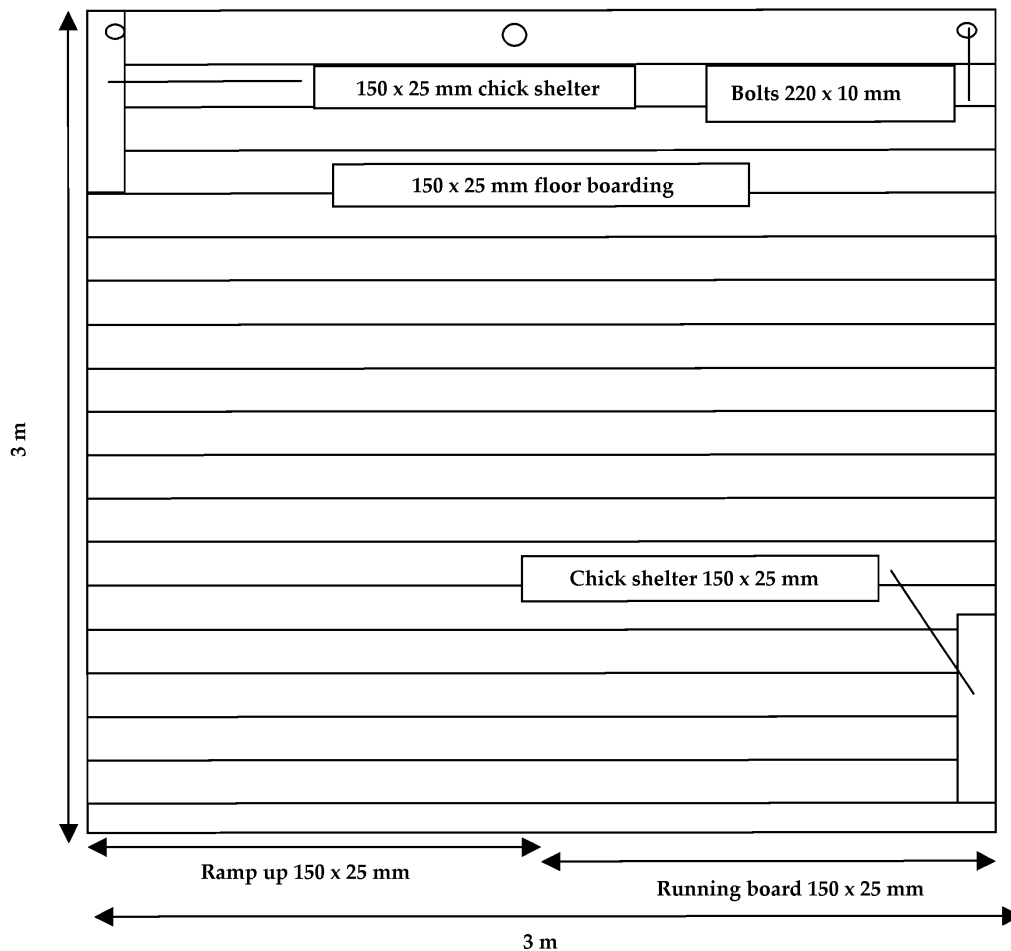

### A floating wildfowl nest for use on rivers

This design, successfully used on the Ray, near Oxford, is intended to overcome the problems posed by strong currents, which make it difficult for wildfowl to nest successfully on rivers. Chick survival is best where the floating nest is sited on a quiet backwater with gently sloping banks so that, when a chick leaves the nest, it can get to the shore and climb out despite the current.

1. Drive a suitable length of 50mm diameter steel pipe into the riverbed to provide an anchor pole on which the floating nest can rise and fall with changes in water level.
2. Cut out a circular platform from marine plywood and cut a hole in its centre so that it fits over the anchor pipe.
3. Screw three boards to the circular plywood piece, so that they form an equilateral triangle to make a frame underneath the platform for the floats.
4. Strap three 4.5 litre plastic or metal tins to the triangular frame, one each side. If metal tins are used, they should be well painted with bitumen paint and coated inside with a spoonful of old engine oil before capping.
5. Attach three metal struts, evenly spaced, to the edge of the platform, joined at the upper end to a ring that fits over the anchor pipe. This upper ring, with the hole in the platform, forms the bearing on which the nest rises and falls on the pipe.

6. Fasten a conical covering of light but firm netting around the outside of the strut assembly, and use vegetation to provide some shelter. Leave a 150 mm diameter entrance on one side.
7. Slide the platform down over the pipe. If it tends to spin in the current, attach a rudder to the floats to keep it properly orientated. The entrance hole should be arranged to face the nearest bank.

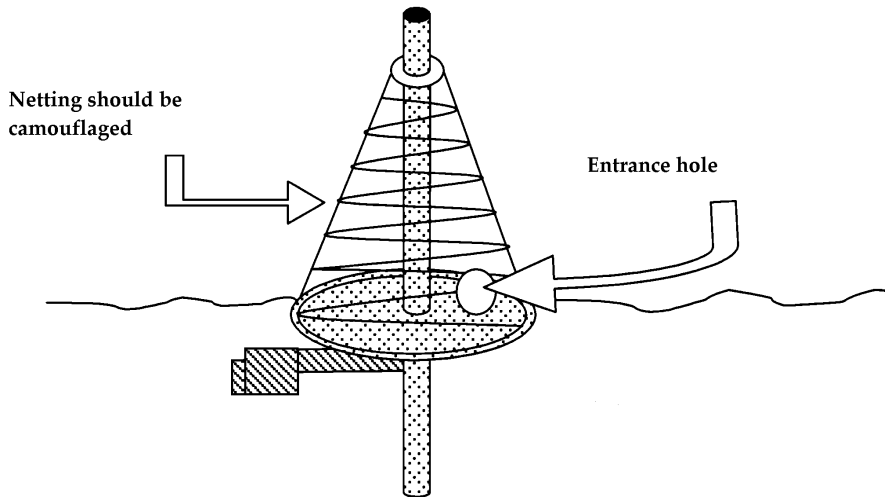

### A square raft

This design is popular and has proved to be highly effective and weatherproof. Similar structures are in use in many reserves.

- a. Construct a framework of 25 x 150mm boards or similar. Nail the flooring across the top of the frame leaving the margins open to take vegetation and nail duckling ramps to one end of the raft. Use galvanized nails since they do not rust.

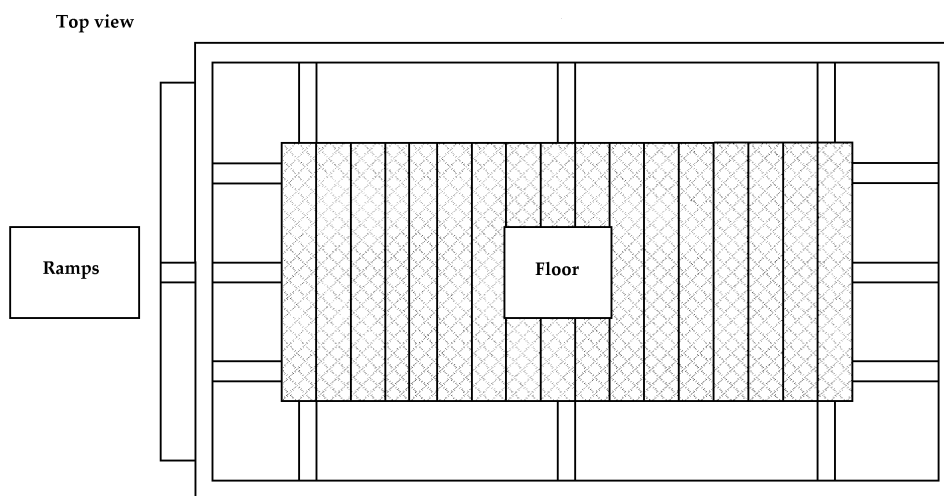

- b. Turn the raft over. Staple close-mesh galvanized wire netting across the bottom of the raft, leaving the central part free to hold the flotation blocks.
- c. Place 150mm thick polystyrene blocks in the uncovered centre of the frame. Hold the polystyrene in place with diagonal boards nailed across the frame.

Underside view

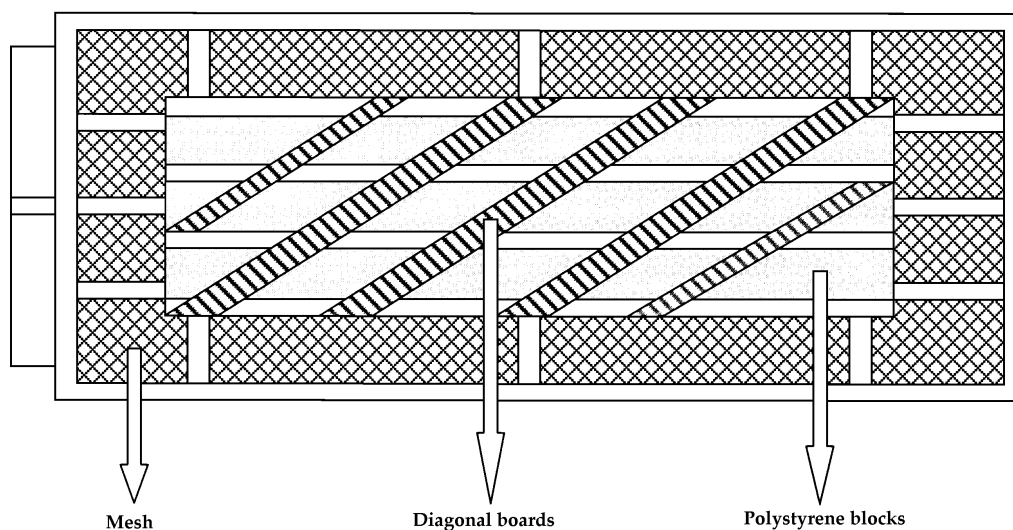

- d. Turn the raft right way up. Cut out blocks of rush, willow etc. to fit into the margins of the frame. Fit anchor bolts to two opposite corners. Fix a nesting box or basket if required. You can cover the raft with some gravel. Finally, tow the raft into the position and anchor it firmly.

***A heavier variation:***

The raft described below is very successful when attracting terns to nest. Bare shingle is required for the nesting, but a completely exposed raft results in high chick mortality. At about one week old, tern chicks leap overboard at the slightest disturbance. This can be prevented by providing them with small shelters to hide underneath.

1. Drill the sleepers as indicated in the diagram, using a brace and a bit, and bolt them together with eight 250mm coach bolts. Drill and fix anchor bolts in the end sleepers.
2. Drill and bolt the cross members to the side sleepers. These are required to make a rigid structure and to resist the upward pressure of the floats.
3. Nail the side battens into position; these help hold the shingle in place.
4. There are two ways to floor the raft. One is to trap plastic-coated chain link fencing, covered in heavy-duty polythene, under the cross braces. Staple the fencing firmly to the sleepers. Alternatively, nail old garage doors or other suitable sturdy timber to the cross members and spread the flooring with a layer of concrete to help keep the shingle in place.
5. Float the raft. Unless you have mechanical help, placing approximately 0.8 cubic metres of polystyrene blocks under the raft for flotation will require a number of water-hardy volunteers.
6. The amount of polystyrene needed varies with the weight of the raft so trials are necessary. Provide some extra flotation to compensate for the shingle, which is added afterwards. The polystyrene stays in place between the sleepers due to its buoyancy and should not need fastening.
7. Spread a layer of shingle over the flooring.
8. Fix ramps or walls to the rafts sides, place a shelter on it, tow it into position and anchor it by means of bolts in the end sleepers.

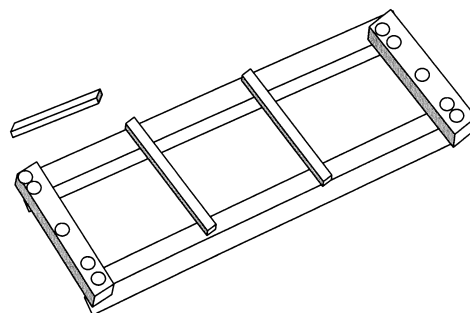

## Welded Rafts

These two models were designed for the specific needs of a particular area. They require a great deal of skills and therefore are only suitable if none of the previous ones can be used. The designs shown have proved to have an estimated life of at least 12 years with minimal maintenance. These types depend on availability of suitable welding equipment and skills, and sheet-metal float tanks used by gravel companies for ferrying electrical equipment around wet pits.

### *Type A*

Weld together three float tanks and attach a rim of logs with welded metal straps. To moor the raft, fix a wire anchor rope to a 50 kg scrap iron or concrete anchor. This simple but strong raft gives a surface area of 6.7 square metres. It successfully attracts ducks and geese, but has two disadvantages. It is so buoyant that the nest floats at least a foot above the water so that, unless a ramp is attached to help them, once the chicks leave the raft they cannot return. Soil ultimately dries out or is dislodged and must be replaced at intervals along with fresh vegetation.

### *Type B*

This rather elaborate design features a semi-flexible welded frame, which makes the raft very durable in exposed conditions. The float tanks are the same size as in the previous design; the sleepers are topped with a grid that holds nesting cover.

#### Construction:

- Weld the frame together and to the float tanks. Weld two anchor bolts to opposite corners.
- Manoeuvre the completed frame into the water.
- Slide the sleepers into position. Leave gaps between the pairs of sleepers so that plant roots can reach the water.
- Cover the top of the frame's central section with narrow-mesh galvanized metal.
- Fix the nesting boxes on top of the floats
- Cover the mesh with mulch or soil and suitable plants. Plant up the nesting boxes.
- Tow the raft into position and anchor from the anchor bolts.

